

## AC-coupled Inverter

# Quick Installation Guide

---

HAT-5.0HV-EUG1  
HAT-6.0HV-EUG1  
HAT-8.0HV-EUG1  
HAT-10.0HV-EUG1

## 1 General Declaration

- The information in this quick installation guide is subject to change due to product updates or other reasons.
- This guide cannot replace the product labels or the safety precautions in the user manual unless otherwise specified. All descriptions here are for guidance only.
- Before installations, read through the quick installation guide and the user manual to learn about the product and the precautions.
- All installations should be performed by trained and knowledgeable technicians who are familiar with local standards and safety regulations.
- Check the deliverables for correct model, complete contents, and intact appearance. Contact the manufacturer if any damage is found or any component is missing.
- Use insulating tools and wear personal protective equipment when operating the equipment to ensure personal safety. Wear anti-static gloves, clothes, and wrist strip when touching electron devices to protect the inverter from damage. The manufacturer shall not be liable for any damage caused by static electricity.
- Strictly follow the installation, operation, and configuration instructions in this guide and user manual. The manufacturer shall not be liable for equipment damage or personal injury if you do not follow the instructions.
- All cables in this article are copper cables.

## 2 Packing List

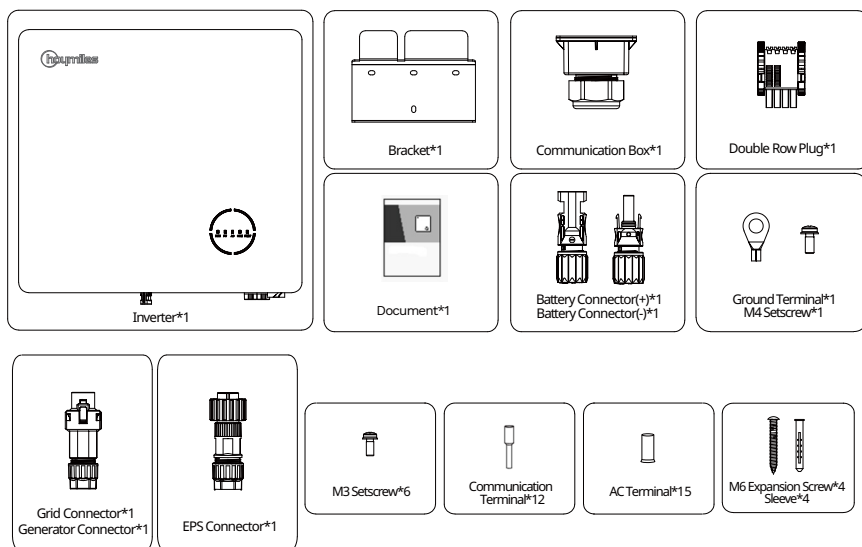

### Accessories packing list

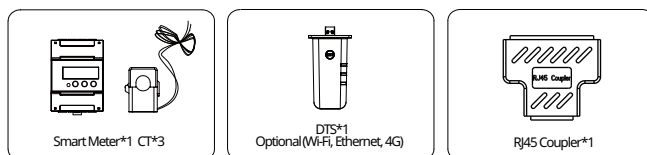

### 3 Mounting the Inverter

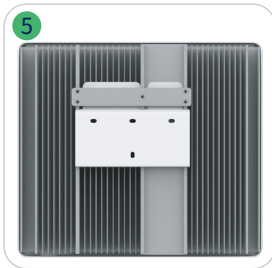
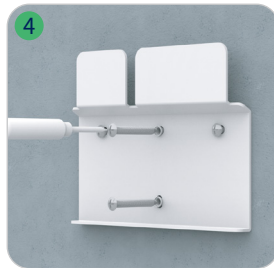
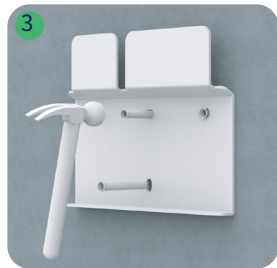
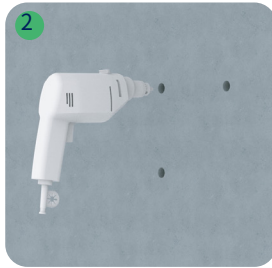
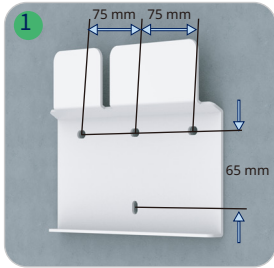
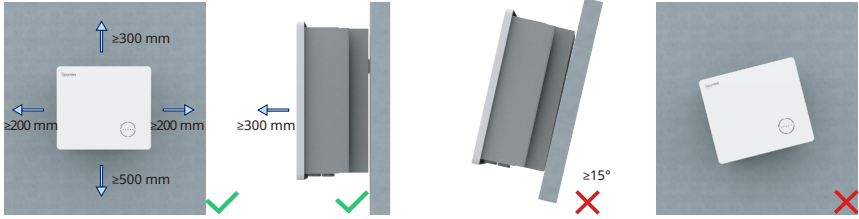

## 4 Wiring Diagram

Wiring diagram for countries such as Australia, New Zealand, South Africa, etc.  
 Please follow local wiring regulations.

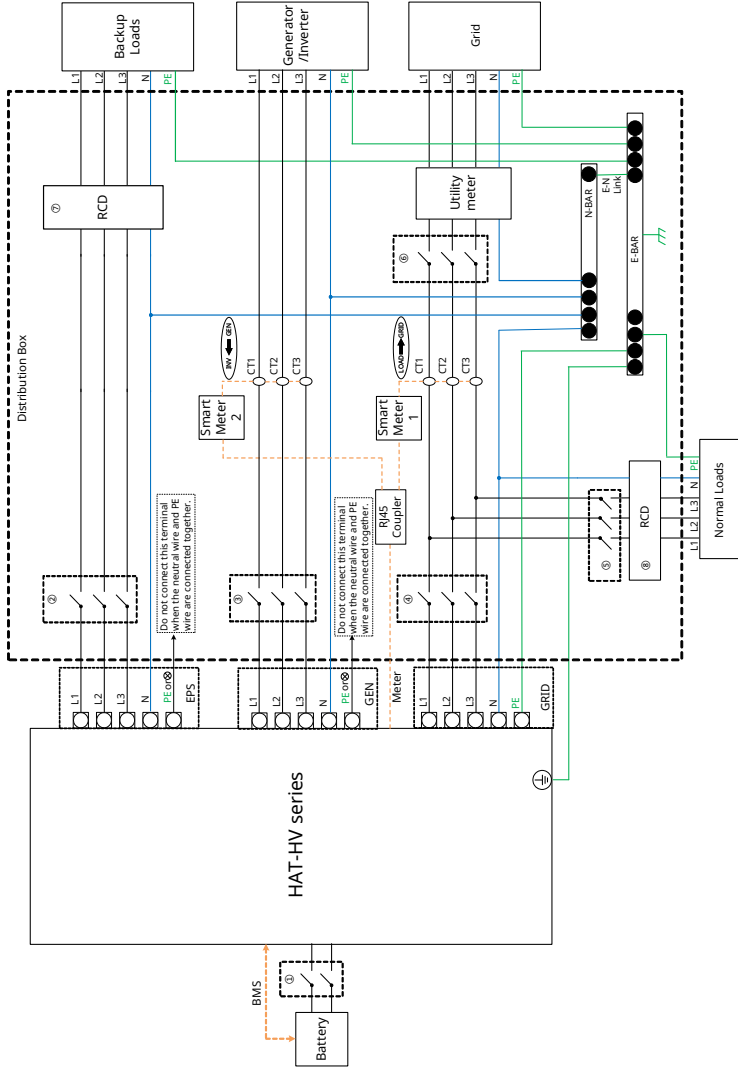



Model	①	②	③	④	⑤	⑥	⑦⑧
HAT-5.0HV-EUG1	25 A/600 V DC Breaker	16 A/400 V AC Breaker	16 A/400 V AC Breaker	20 A/400 V AC Breaker	Depends on Loads	Main Breaker	30 mA RCD
HAT-6.0HV-EUG1	25 A/600 V DC Breaker	16 A/400 V AC Breaker	16 A/400 V AC Breaker	25 A/400 V AC Breaker			
HAT-8.0HV-EUG1	40 A/600 V DC Breaker	20 A/400 V AC Breaker	20 A/400 V AC Breaker	32 A/400 V AC Breaker			
HAT-10.0HV-EUG1	40 A/600 V DC Breaker	25 A/400 V AC Breaker	25 A/400 V AC Breaker	32 A/400 V AC Breaker			

**Note:**

- If the battery has integrated a readily accessible internal DC breaker, then no additional ① DC breaker is required.
- The use of ⑦⑧ 30 mA RCD is recommended but not mandatory; please comply with local regulations for the system installation.

Wiring diagram for other countries, please follow local wiring regulations.

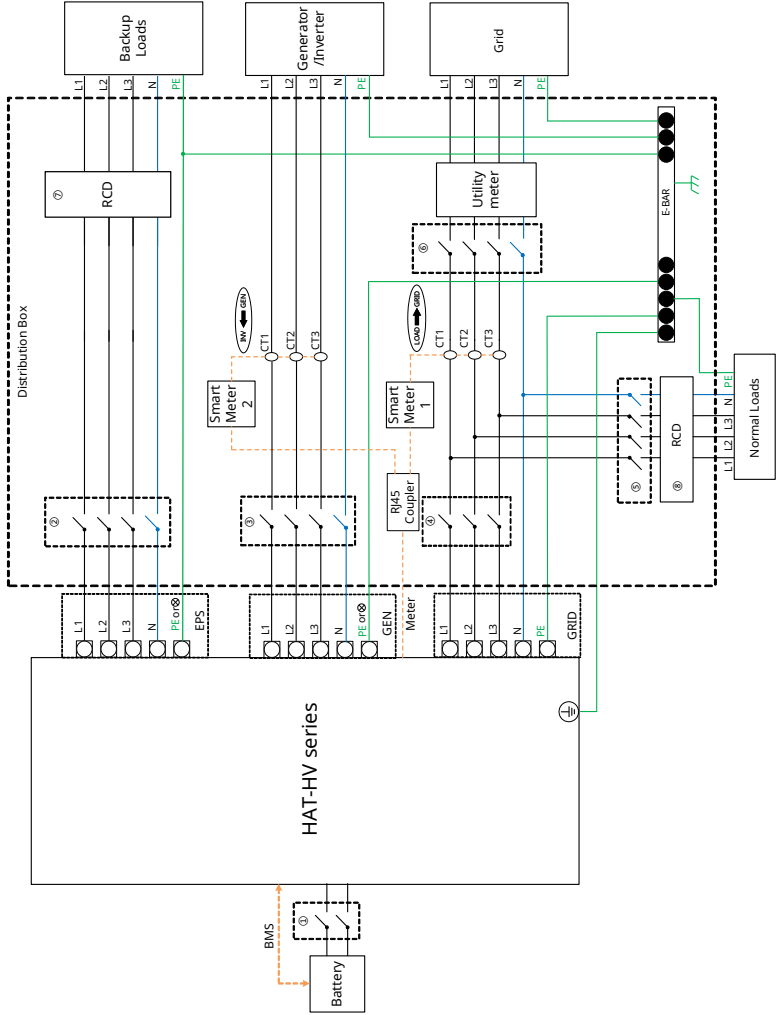

Model	①	②	③	④	⑤	⑥	⑦⑧
HAT-5.0HV-EUG1	25 A/600 V DC Breaker	16 A/400 V AC Breaker	16 A/400 V AC Breaker	20 A/400 V AC Breaker	Depends on Loads	Main Breaker	30 mA RCD
HAT-6.0HV-EUG1	25 A/600 V DC Breaker	16 A/400 V AC Breaker	16 A/400 V AC Breaker	25 A/400 V AC Breaker			
HAT-8.0HV-EUG1	40 A/600 V DC Breaker	20 A/400 V AC Breaker	20 A/400 V AC Breaker	32 A/400 V AC Breaker			
HAT-10.0HV-EUG1	40 A/600 V DC Breaker	25 A/400 V AC Breaker	25 A/400 V AC Breaker	32 A/400 V AC Breaker			

**Note:**

- If the battery has integrated a readily accessible internal DC breaker, then no additional ① DC breaker is required.
- The use of ⑦⑧ 30 mA RCD is recommended but not mandatory; please comply with local regulations for the system installation.

## 5 Electrical Connection

### Step 1 Grounding Protection Wire

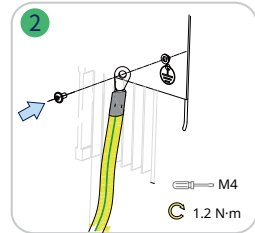
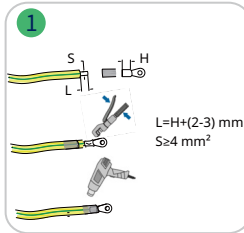

### Step 2 Grid (Same wirings for GEN if needed)

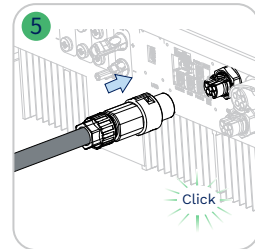
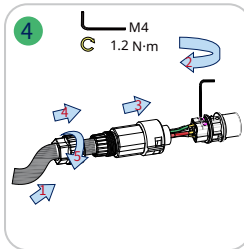
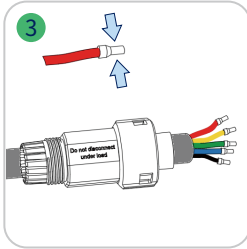
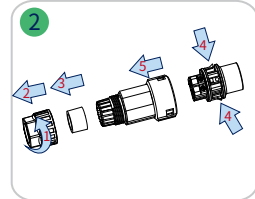
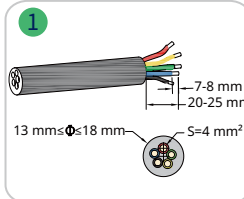

### Step 3 EPS

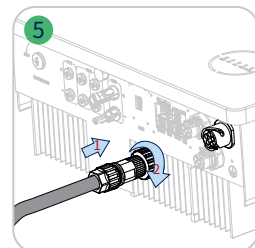
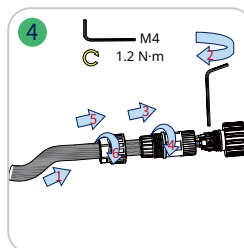
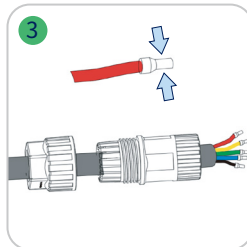
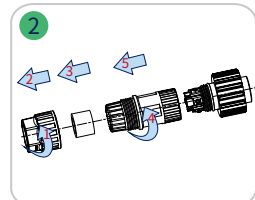
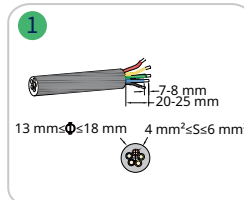

### Step 4 Battery

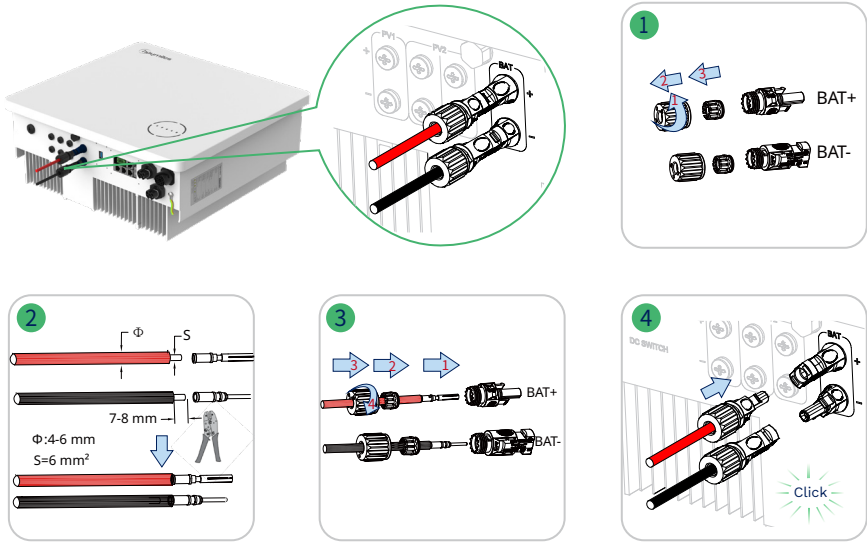

### Step 5 Signal Communication (Connection of communication box is mandatory)

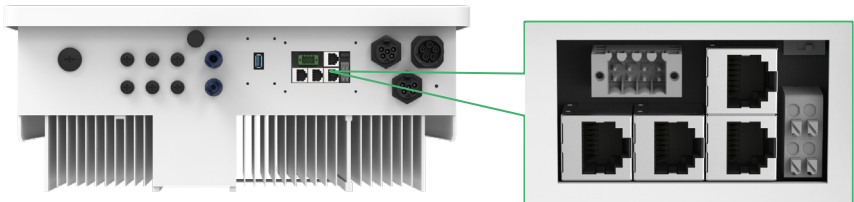

DI	DRM			 Para1	8-485A_2 7-485B_2 6-485A_1 5-485B_1 4-CANL 3-CANH 2-DI IN- 1-DI IN+	120 Ohm		
2	4	6	8			ON	OFF	
IN-	D2/6	D4/8	REF	 Meter	8-NC 7-NC 6-NC 5-485B 4-485A 3-NC 2-NC 1-NC	DO1		
1	3	5	7			1	2	
IN+	D1/5	D3/7	COM	 BMS	8-485B 7-485A 6-NC 5-CANL 4-CANH 3-NC 2-NC 1-NC	NO1		COM1
						1	2	
				 Para2	8-485A_2 7-485B_2 6-485A_1 5-485B_1 4-CANL 3-CANH 2-DI IN- 1-DI IN+	DO2		
						1	2	
						NO2	COM2	

Label	Description
Meter (485A, 485B)	For the Smart Meter.
BMS (CANH, CANL, 485A, 485B)	For Li-ion battery, communication is via CAN or RS485.
DRM (D1/5, D2/6, D3/7, D4/8, REF, COM)	For external Demand Response Enabling Device.
DI (IN-, IN+)	Dry-contact input of external bypass contactor.
Parallel (DI IN+, DI IN-, CANH, CANL, 485A_1, 485B_1, 485A_2, 485B_2)	For parallel operation.
120 Ohm (ON, OFF)	120 Ohm termination resistor for parallel operation.
DO1 (NO1, COM1)	Dry-contact output. The DO1 can be set to one of the functions as follows: Earth Fault Alarm, Load Control and Generator Control.
DO2 (NO2, COM2)	Dry-contact output. The DO2 will control the bypass contactor under certain logic.

### RJ45 Terminal Connection (METER, BMS)

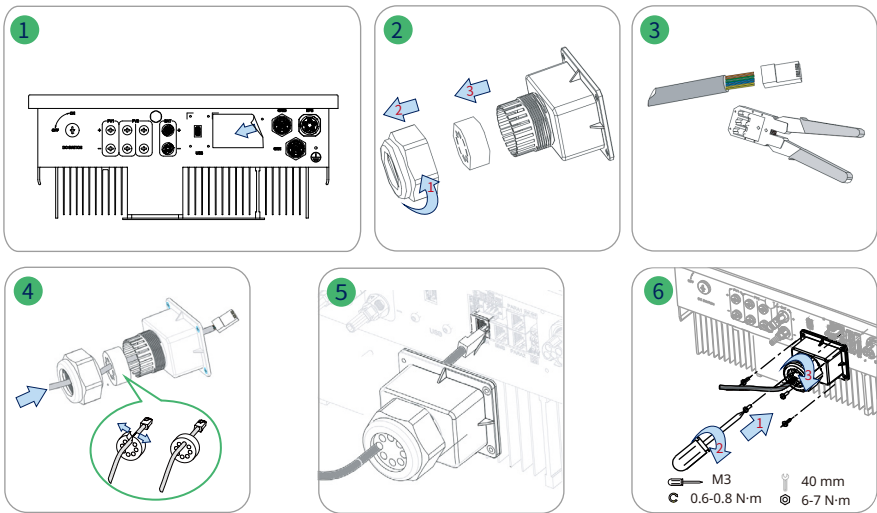

## Step 6 Data Transfer Stick (DTS)

### WIFI and 4G Connection

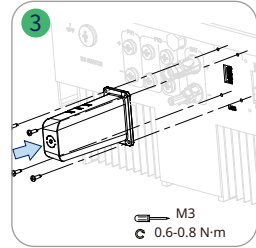
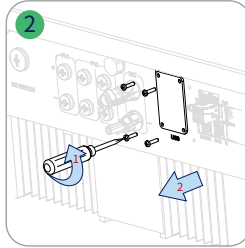
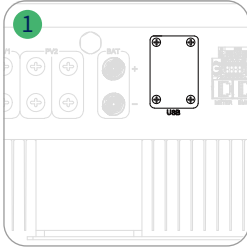

### Ethernet Connection

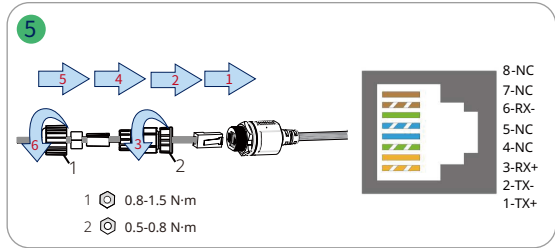
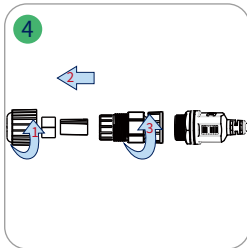
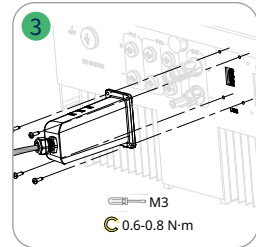
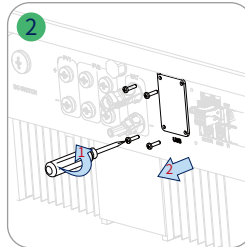
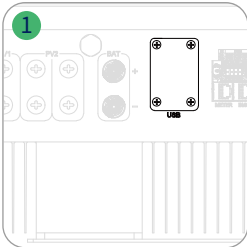

## 6 DTS Online Setting

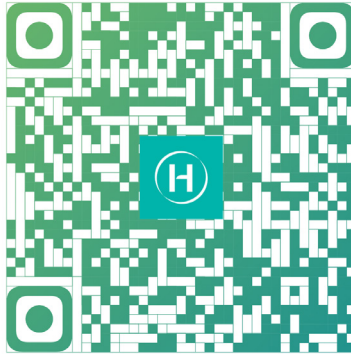

1. Search "Hoymiles" in the App Store (iOS) or the Play Store (Android), or scan the QR code to download the Hoymiles Installer App.
2. Open the App and log in with your installer account and password. For new Hoymiles installers, please apply for an installer account from your distributor in advance.
3. Use the App to connect to the DTS.
  - (a) Open the Installer App on smartphone/tablet and log in. Click on "O&M" at the bottom of the page, and then click on "Network Config".

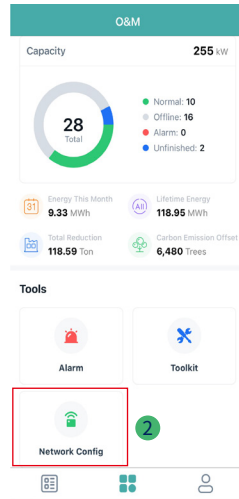
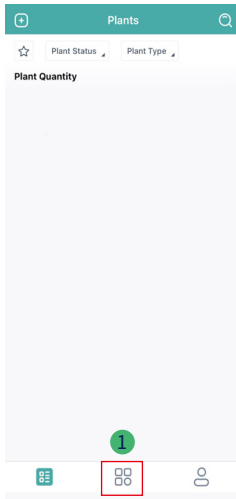



(b) Select the DTS's wireless network and click "Connect". (The network name of the DTS consists of DTS and product serial number, and the default password is **ESS12345**.)

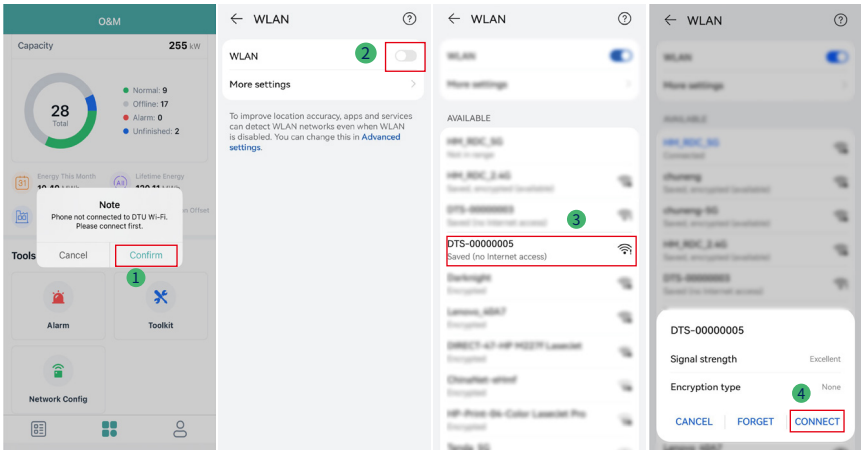

4. Network configuration.

- (a) Upon successful connection, click on "Network Config" again and access the Network Configuration page.
- (b) Select the router Wi-Fi and enter the password.
- (c) Click on "Send to DTU".

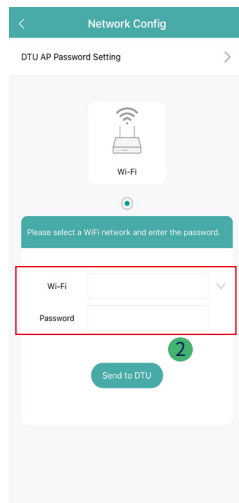

5. Check the DTS indicator for a solid blue light, which signifies a successful connection.

The network configuration takes about 1 minute, please be patient. If the network is not connected, please check the internet as instructed.

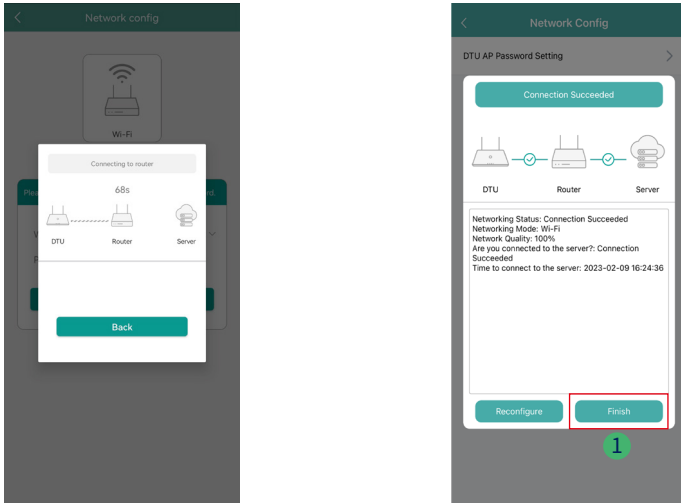

## 7 System Commissioning of Wireless Access Point (AP) Connection

1. Connect the wireless network of DTU. Open the App, choose "Toolkit → Generator Setting", click the corresponding button according to whether the device connected to the GEN port is "PV Generator" or "Diesel Generator", and then click "Save". (The default option is "None".)

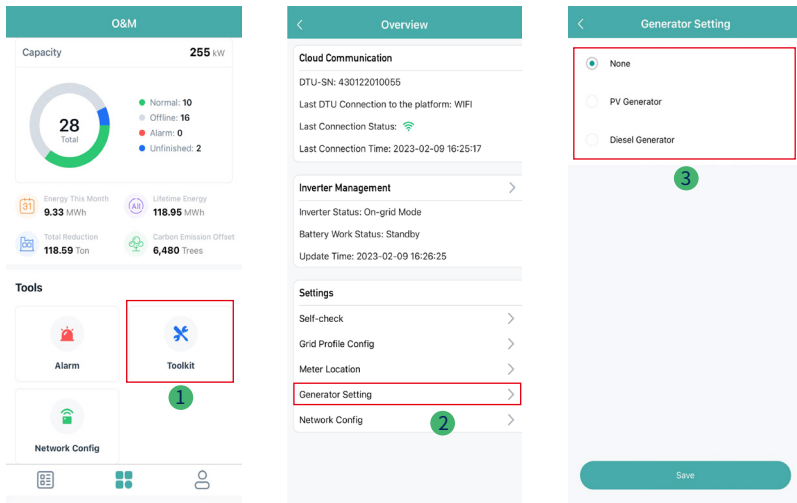

2. Click the “Meter Location” to configure the grid side meter. The serial number (SN) can be entered manually or identified through scanning the QR code. If the GEN port is connected with the PV generator or diesel generator, the PV side meter also needs to be configured.

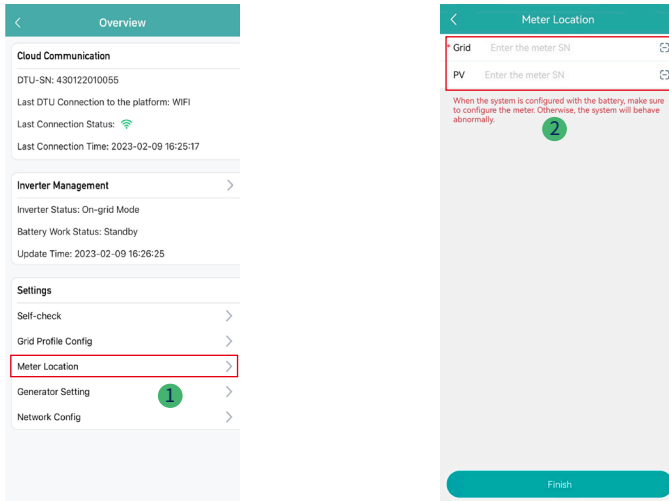

3. Click on “O&M → Toolkit”, access the Overview page and click the “Self-check”. The self check can be completed after PV, battery, grid, EPS and GEN are properly connected.

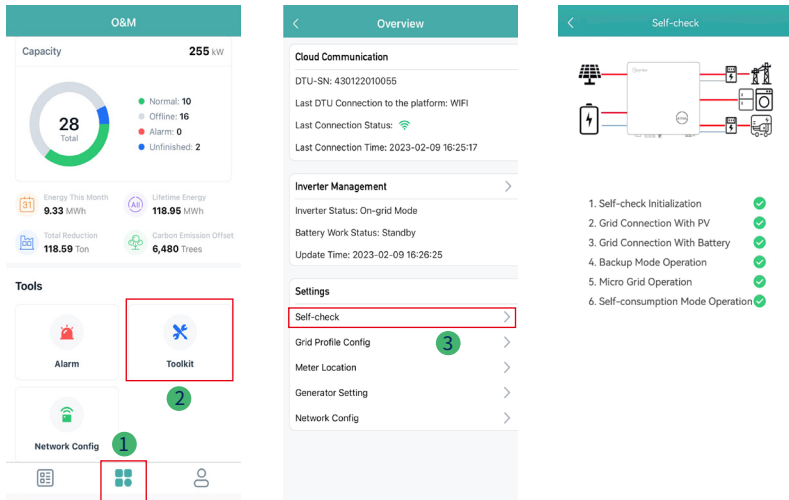



User Manual in the QR code or at  
[www.hoymiles.com/resources/download/](http://www.hoymiles.com/resources/download/)



**Hoymiles Power Electronics Inc.**

Add: Floor 6-10, Building 5, 99 Housheng Road, Gongshu District,  
Hangzhou 310015, P. R. China

Tel: +86 571 2805 6101

Email: [service@hoymiles.com](mailto:service@hoymiles.com)

[support@hoymiles.com](mailto:support@hoymiles.com)

[www.hoymiles.com](http://www.hoymiles.com)



AP040766